

---

GUIDE

# Motors and drives in potentially explosive atmospheres

What do you need to know



# Overview

A potentially explosive atmosphere is defined as a location in which gases, vapors, mist or dust mixed with air can form a flammable mixture. Electrical and mechanical equipment installed in such locations must be designed and tested in such way that it does not cause arcing, sparking nor such high temperatures that could provide a source of ignition for such a mix.

The purpose of this brochure is to provide the reader with basic information on the regulations, standards, definitions and equipment requirements for motors and drives in potentially explosive areas.



---

# Table of contents

<b>04–05</b>	<b>What is a potentially explosive atmosphere?</b>
<b>06–07</b>	<b>Understanding the standards for explosive atmospheres</b>
<b>08–09</b>	<b>Main standards for explosive atmospheres</b>
<b>10–11</b>	<b>Groups</b>
<b>12–13</b>	<b>Zones, categories and equipment</b>
<b>14–15</b>	<b>Motor protection types</b>
<b>16</b>	<b>Certification markings</b>
<b>17–19</b>	<b>The effects of variable speed drives on motors</b>
<b>20–21</b>	<b>ATEX-certified safety functions</b>
<b>22–23</b>	<b>Selecting motors and drives for explosive atmospheres</b>



---

# What is a potentially explosive atmosphere?

Explosive atmosphere occurs when a suitable mixture of flammable gas, mist, vapor or dust together with air is formed. This creates the risk of an explosion.

The area where this possibility exists is defined as a **potentially explosive atmosphere**. These atmospheres can be found in many industries, from chemical, pharmaceutical and food, to power generation and wood processing. The areas may also be known as “hazardous areas” or “hazardous locations.”

The number of substances that are flammable when mixed with air is very large. This means there are many industrial sectors that can have a potentially explosive atmosphere somewhere in their process. Some of these are not so obvious. For example, sawmills by default are not a potentially explosive atmosphere, but if sawdust is allowed to collect in large amounts in one area, that area can become one.



# Understanding the standards for explosive atmospheres

Globally, there are many national regulations and certification systems with different requirements. The technical requirements in these regulations are increasingly harmonized with the global IEC standards.

## IECEX

The IECEx system ([www.iecex.com](http://www.iecex.com)) – from the International Electrotechnical Commission, is a voluntary certification system that verifies compliance with IEC standards related to safety in explosive atmospheres. IECEx covers four main areas:

- Certification of service facilities
- Equipment certification
- Ex marking conformity
- Certification of Personnel Competencies

## European Directives

Commonly referred to as ATEX, from the French “ATmosphères EXplosibles”, the European regulations combine two EU directives: the Worker Protection Directive (1999/92/EC) and the Product Directive (2014/34/ EU). The EU Directives have some difference from IECEx, and they do not include certification of service facilities or certification of personnel competencies. Compliance with the “Essential Health and Safety Requirements” described in the directives is mandatory within EU countries. The easiest way to show compliance is to follow harmonized standards.

UKCA marking (UKEX) is the UK product marking requirement that will be needed for all Ex products being placed on the market in Great Britain, substituting the EU requirements for CE Marking.

## Protective devices

Protective devices are often required by IEC 60079 series of standards for safe operation of Ex equipment. Protective devices can be located inside or outside explosive atmospheres. A typical example of a protective device is surface temperature protection for motors controlled by a variable-speed drive (VSD). This type of protective device is an alternative to a certified and tested combination of motor and VSD.

Protective devices for Ex equipment and products fall within the scope of the ATEX (and UKEX in United Kingdom) regulations: harmonized (designated) standard EN 50495:2010. IEC does not have an applicable standard for electrical safety devices for Ex equipment, and therefore certification can only be done according to ATEX (and UKEX). However, IEC publication (IEC TS 60079-42) gives guidance on protective devices under IECEx. Also remember to always check the local regulations as well.





# Main standards for explosive atmospheres

## IEC and EN standards

- IEC 60050-426 Equipment for explosive atmospheres
- IEC/EN 60079-0: Equipment – General requirements
- IEC/EN 60079-1: Equipment protection by flameproof enclosures “d”
- IEC 60079-2: Equipment protection by pressurized enclosure “p”
- IEC/EN 60079-7: Equipment protection by increased safety “e”
- IEC/EN 60079-10: Classification of hazardous areas (gas areas)
- IEC 60079-10-1: Classification of areas – Explosive gas atmospheres
- IEC 60079-10-2: Classification of areas – Combustible dust atmospheres
- IEC/EN 60079-14: Electrical installations design, selection and erection
- IEC/EN 60079-15: Equipment protection by type of protection “n” (no longer applicable to rotating machines)
- IEC/EN 60079-17: Electrical installations inspections and maintenance
- IEC/EN 60079-19: Equipment repair, overhaul and reclamation
- IEC/EN 60079-31: Equipment dust ignition protection by enclosure “t”

## Regulations around the globe

### CEC

### NEC

### INMETRO

### OHSA ACT 85 AND REGULATION 17 OF THE ELECTRICAL MACHINERY REGULATIONS

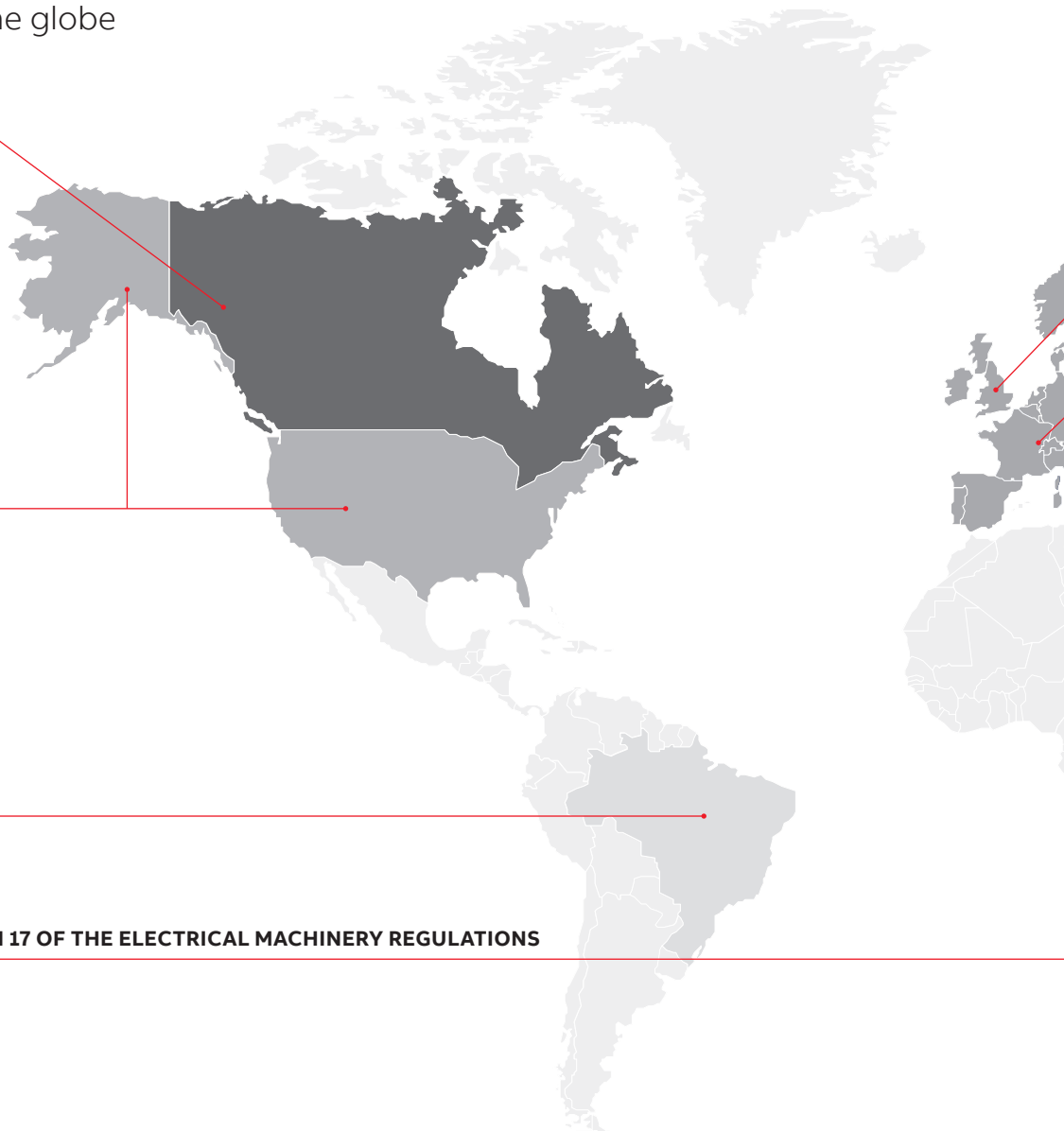



**ATEX directives**

**The Worker Protection Directive (1999/92/EC)** specifies the minimum health and safety requirements for workers performing duties in potentially explosive atmospheres.

**The Product Directive (2014/34/EU)** specifies requirements for equipment that is used in potentially explosive atmospheres. It also specifies the requirements for protective systems that are needed for equipment protection.

**In addition to IECEx and ATEX** there are several local standards that may be in effect in certain countries.

**Other standards**

Many countries have regulations concerning both the design and use of electrical devices in potentially explosive atmospheres, and these may differ. These regulations are recognizing IECEx Test Reports widely but may require some additional documentation, testing and local product certification is mandatory. National requirements may still need to be met for final approval of installation (e.g. in Russia, Brazil, Australia or Japan), but they generally relate to one of the main standards below. In such countries having not implemented their own Ex safety regulations either IECEx or ATEX certificate may be recognized.

- IEC: International Electrotechnical Commission
- EN: European standard
- NEC/CEC: National Electrical Code / Canadian Electric Code (500 or 505) in North America

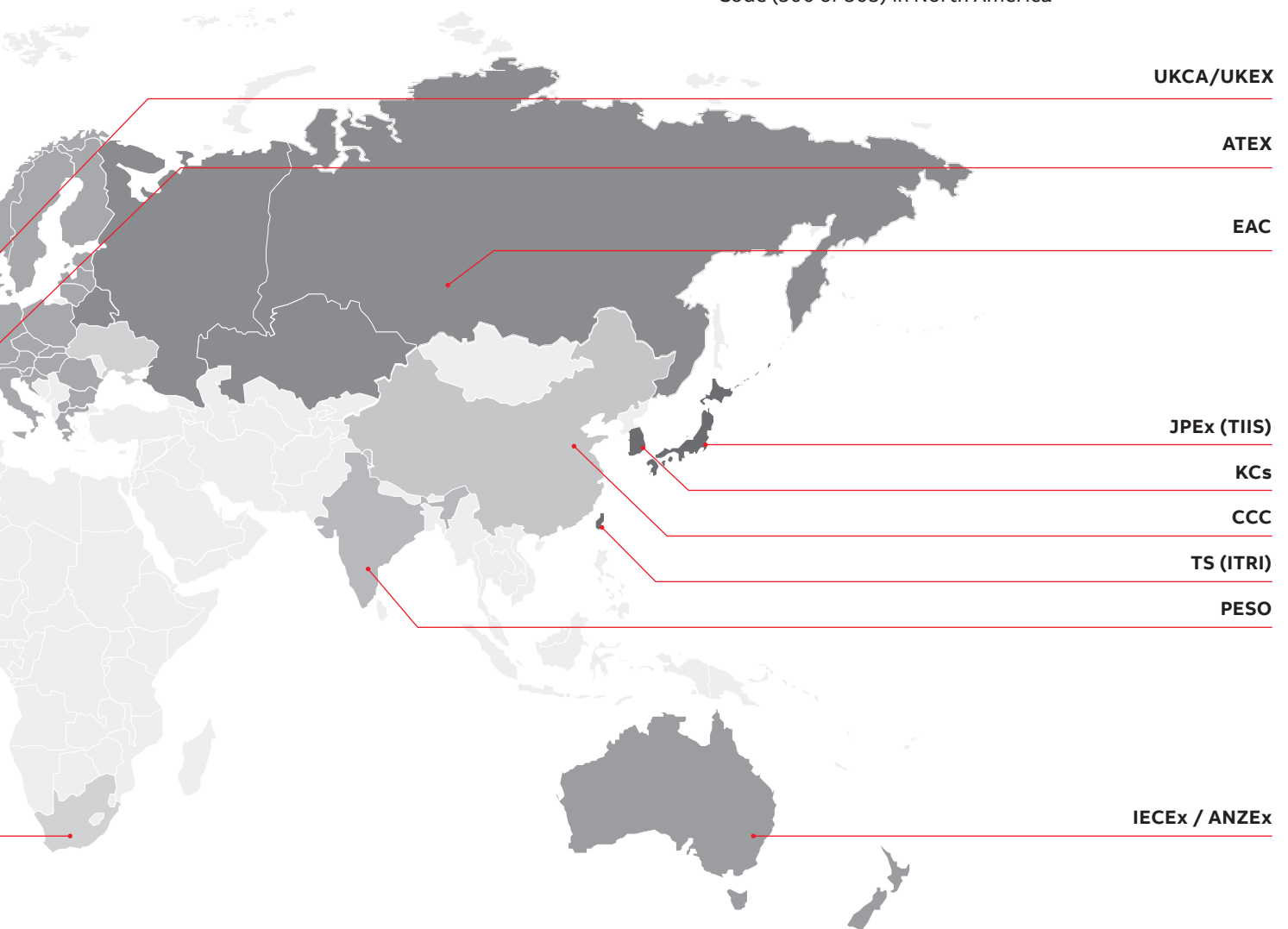

# Groups

## Groups

Internationally, IEC 60079-0 and EN 60079-0 in Europe define three groups for potentially explosive atmospheres: Group I covers underground mines or mines susceptible to firedamp. Group II relates to surface environments with gas, and Group III to surface environments with dust. The Product Directive defines only two groups: Group I for underground mines or mines endangered by firedamp and/or combustible dust, and Group II for all surface installations.

The group designation is essentially based on where equipment can be used (equipment classification).

## Subgroups and temperature classes

Explosive gases, vapors and dusts have different chemical properties that affect the likelihood and severity of an explosion. Such properties include flame temperature, minimum ignition energy, upper and lower explosive limits, and molecular weight. Based on the nature of the explosive gas/dust, gases are grouped into IIA, IIB and IIC and dusts into IIIA, IIIB and IIIC.

Temperature classes are defined for equipment based on its maximum surface temperature. When selecting a piece of equipment for a potentially explosive atmosphere, the maximum surface temperature of the equipment must be lower than the ignition temperature of the potential gas or dust mixture.

### Gas classification

Temp. class	Ignition temp. of gas/vapor (°C)	Max. permitted temp. of equipment (°C)	Gas examples
T1	> 450	450	Hydrogen
T2	> 300 but < 450	300	Ethanol
T3	> 200 but < 300	200	Hydrogen sulfide
T4	> 135 but < 200	135	Diethyl ether
T5	> 100 but < 135	100	–
T6	> 85 but < 100	85	Carbon disulfide

### Gas subdivision

IIA	Approx. 120 gases and vapors, e.g. butane/petroleum/propane
IIB	Approx. 30 gases and vapors, e.g. ethylene/dimethyl ether/coke oven gas
IIC	Three gases: hydrogen (H <sub>2</sub> )/acetylene (C <sub>2</sub> H <sub>2</sub> ) / carbon disulfide (CS <sub>2</sub> )

**Dust classification**

		TCL (cloud) (°C)	T5mm (layer) (°C)	Surface temp. provided that dust layer below 5 mm
<b>Food/feed industry</b>	Wheat	350	270	195
	Barley, corn	380	280	205
	Sugar	350	430	233
<b>Natural materials</b>	Wood	330	280	205
	Charcoal	520	230	195
	Hard coal	460	240	165
<b>Chemicals</b>	PVC	450	330	255
	Synth. rubber	470	220	145
	Sulfur	240	250	160

**Dust subdivision**

<b>IIIA</b>	Combustible flyings
<b>IIIB</b>	Non-conductive dust
<b>IIIC</b>	Conductive dust

Relationships between ATEX directives

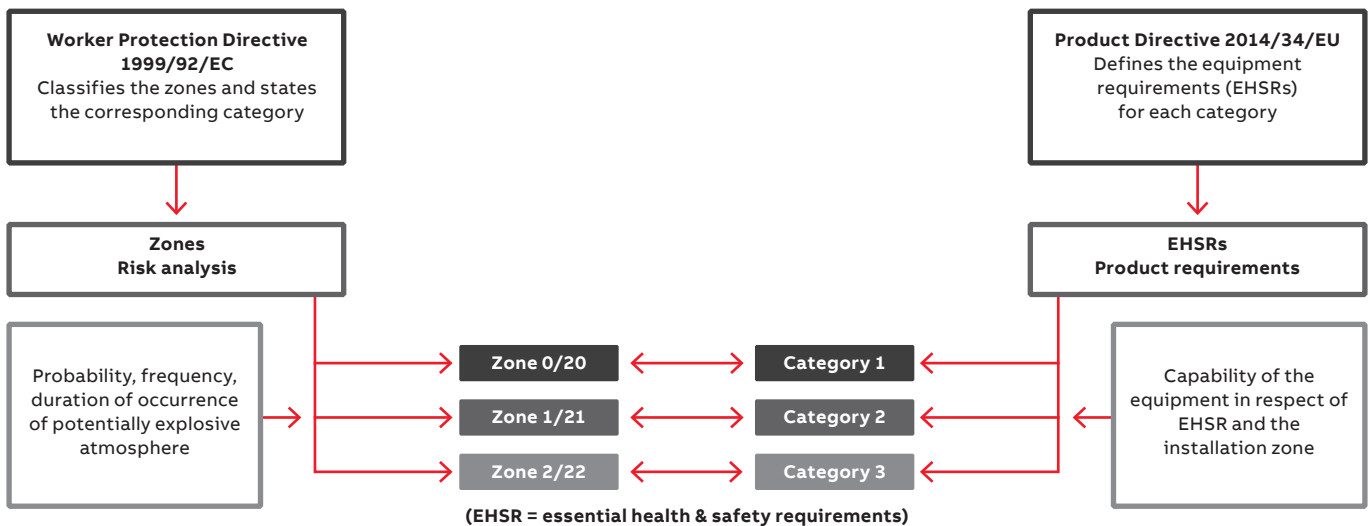

The manufacturer is responsible for product safety and for delivering installation and maintenance instructions. The Product Directive guides the manufacturer to prepare the product classification and to certify the product and production.

The end user is responsible for ensuring that the product is installed, maintained and operated in a way that does not pose any risk of explosion. The Worker Protection Directive guides end users to use certified products and to prepare risk analysis, safety instructions, training and procedures for operation and maintenance.

# Zones, categories and equipment

## Zones

Within industries, all potentially explosive atmospheres are required to have an area classification called **zones**.

The zone system is used all over the world, and nowadays is also accepted as an alternative system in North America. The authorities normally determine the area, but that can also be performed by a third party; a notified body, or other experts. It is the owner’s responsibility to ensure that their site is classified before suitable products can be selected and installed at the location.

Globally, the zone system is used to classify potentially explosive areas. The Worker Protection Directive and the international standards IEC 60079-10-x and EN 60079-10-x

define these zones. In all cases, classifying the zone is the responsibility of the owner of the site where the potentially explosive atmosphere exists.

There are six zones:

- Zones 0 (for gas) and 20 (for dust), where there is a continuous presence of an explosive atmosphere.
- Zones 1 (for gas) and 21 (for dust), where there is an occasional occurrence of a potentially explosive atmosphere.
- Zones 2 (for gas) and 22 (for dust), where potentially explosive atmospheres can occur by accident, but not during normal operation.

## Equipment groups and zones according to IECEx and ATEX

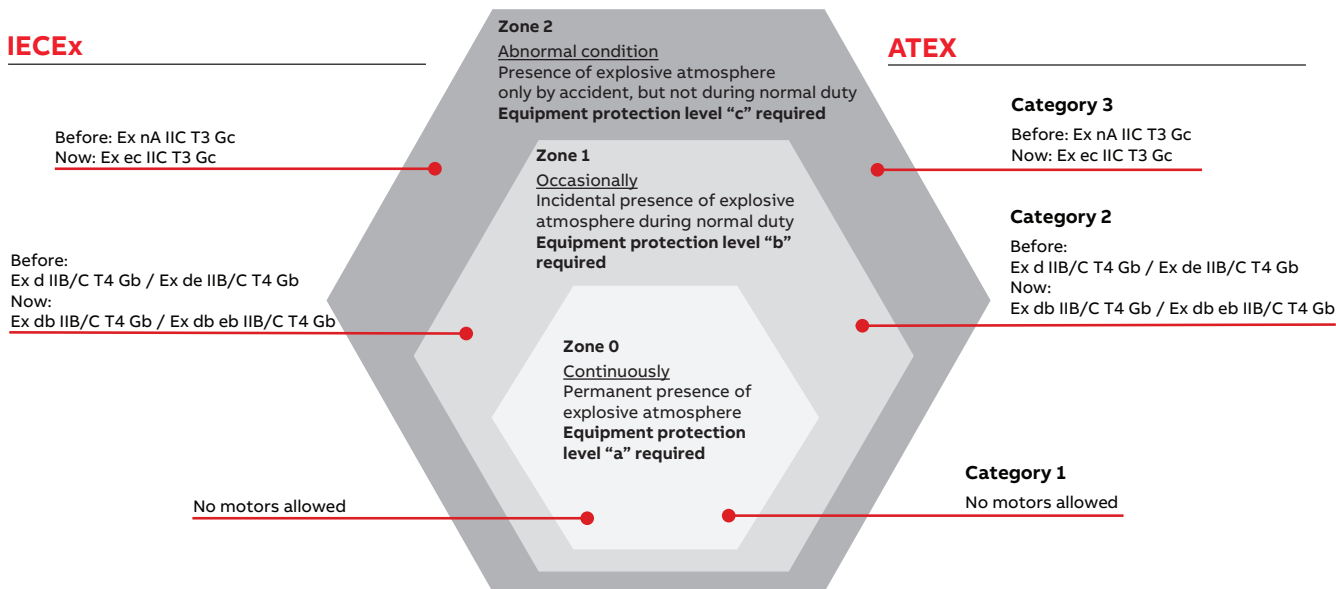

**Equipment categories**

Equipment categories are used in the ATEX directive. The category indicates which safety level must be used in each zone. In zone 0/20, category 1 devices must be used; in zone 1/21, category 2 devices; and in zone 2/22, category 3 devices.

Classification into categories is particularly important, because all the inspection, maintenance and repair duties of the end user will depend on the category of the product/equipment, not on the zone where it is installed.

**Equipment protection levels (EPL)**



The latest revisions of the IEC and EN standards include the concept of “equipment protection levels” (EPLs), which identify products according to the ignition risk they might cause. EPL also considers the potential consequences of an explosion. For zone 0/20, the equipment protection level required would be “a”; for zone 1/21, it would be “b”; and for zone 2/22, the level would be “c”.

Select the motor type according to the zone and category/EPL

Standard IEC 60079-0 EN 60079-0	Zone according to IEC 60079-10-x EN 60079-10-x		ATEX Directive 2014/34/EU	Main motor protection types		
Group	EPL	Protection level	Zones	Equipment group	Equipment category	
I (Mines)	Ma	Very high	The zone classification is not used in mines.	I (Mines)	M1	Requirements according to EN 1127-2
	Mb	High			M2	
II (Gas)	Ga	Very high	0	II (Surface)	1G	No electric motors allowed
	Gb	High	1		2G	Ex d/Ex de Ex p, Ex db, Ex db eb, Ex p, Ex eb (Ex e)
	Gc	Enhanced	2		3G	Ex ec (Ex nA)
III (Dust)	Da	Very high	20		1D	No electric motors allowed
	Db	High	21		2D	Ex tb IP 65
	Dc	Enhanced	22		3D	Ex tc, IP 65/IP 55

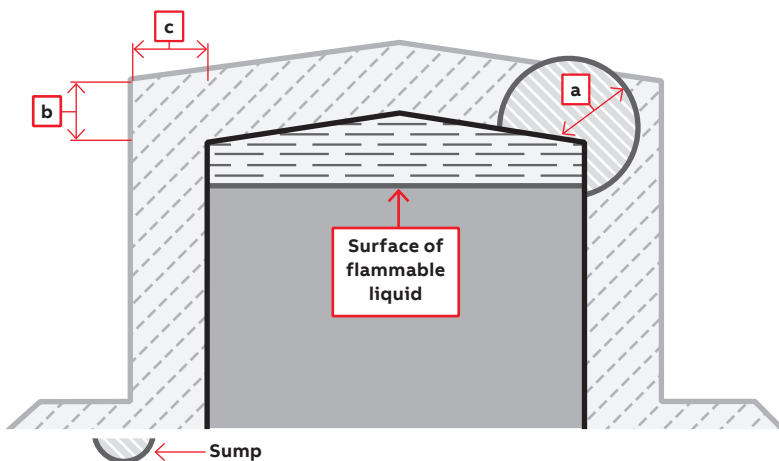
An example of zone definitions: storage tank



-  Zone 0
-  Zone 1
-  Zone 2

Zone distances are determined based on the risk assessment.

- a = Distance from vent opening
- b = Distance from the roof
- c = Horizontal distance from the tank

# Motor protection types

Motors are directly connected to the machines in the potentially explosive atmosphere. These atmospheres have a defined zone classification, and the zone defines the minimum safety level (category) the motors must comply with. The category defines the permitted motor protection types.

## Flameproof

Protection type Ex d

### Protection type Ex d requirement options for use with an AC drive

- The motor has been tested together with the drive for the duty intended and with the protective device provided.
- Or, use direct temperature protection with embedded temperature sensors and with a sufficient margin to protect the bearings or the rotor. The actions of the protective devices used must cause the motor to be disconnected.

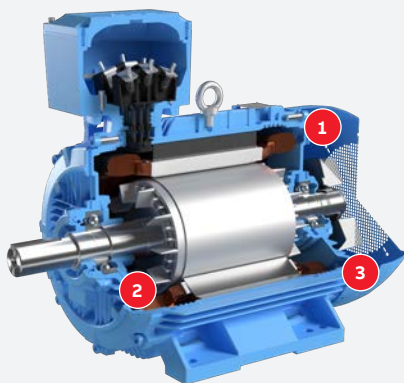

- 1 Joints with long spigots preventing flames escaping to the outside
- 2 Flame paths between shaft and inner bearing covers
- 3 Motor housing developed to withstand an internal explosion

**Only external surface temperature needs to be considered for the Ex temperature class.**

## Increased safety “ec”

Protection type Ex ec

### Protection type Ex ec requirement options for use with an AC drive

- The motor is tested with the drive or a comparable drive.
- Or, the motor’s temperature class is determined by calculation.

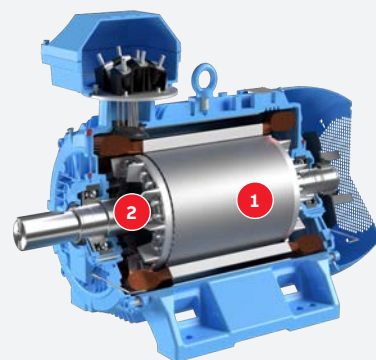

- 1 No hot surfaces in rated conditions
- 2 No sparking during normal running or starting

**Surface temperature of any part (inside or outside) must not exceed the Ex temperature class limit.**

Motors can also be classified by equipment protection level (EPL) according to the IEC/EN standards. The EPL indicates the motor's inherent risk of ignition. The purpose of this classification is to make it easier to select motors for different zones easier.

For motors, the EPL marking is included in the Ex marking, and the equipment category is included in the CE marking.

Classification into categories is particularly important, because all the inspection, maintenance and repair duties of the end user will depend on the category of the product/equipment, not on the zone where it is installed.

Below you can find examples of Ex motor protection types and methods given in the IEC/EN standard to ensure safe operation when a motor is fed from an AC drive.

## Dust-ignition-proof Protection type Ex t

### Protection type Ex t requirement options for use with an AC drive

- The motor has been tested together with the drive for this duty and with the protective device provided
- Or, use direct temperature protection with embedded temperature sensors and with a sufficient margin to protect the bearings or rotor. The action of the protective device must cause the motor to be disconnected.

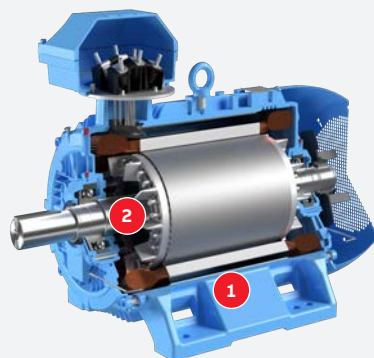

- 1 No hot surfaces outside the enclosure in both rated and fault conditions
- 2 Ingress protection class high enough to ensure no dust can enter the motor

**Only external surface temperature needs to be considered for the Ex temperature class.**

# Certification markings



Example of a flameproof motor according to IECEx and ATEX

Equipment protection marking according to IEC and EN standards

**Ex db IIC T4 Gb**

- Protection type Ex d** (flameproof) with protection level b
- Equipment group II** (gas) and subdivision C (e.g. hydrogen)
- Temperature Class T4** = max. permitted 135 °C
- Equipment protection level** = level b for gas

Complementary marking according to ATEX directive

**CE 0081 Ex II 2G**

- CE marking**
- ID of the notified body responsible for the approval**
- European Commission mark for Ex products**
- Equipment group:** II for surface industry
- Equipment category:** 2G for gas environment demanding a high level of protection



# The effects of variable speed drives on motors

Drives help ensure that motors run according to process demands, helping to save energy and improve process output. But at the same time, using drives introduces additional considerations for motor protection, such as:

- Steep voltage pulses can stress stator winding insulation, potentially leading to sparking.
- Steep voltage rises can also lead to reflected voltages, which can increase the terminal voltage of the motor up to 2.5 times the nominal voltage.
- Common-mode voltages and current can cause sparking in motor bearings, and finally bearing insulation breakdown.
- The surface temperature of the motor may rise due to reduced motor self-cooling when a motor with a shaft-mounted cooling fan is run at lower speeds.
- In overload conditions, the rise in surface temperature of the motor can be steep if it is not taken into account in sizing and if the load capacity curves are exceeded.

## Protecting against voltage phenomena

Due to rapid switching and reflections in the cables, motors are subject to more voltage stress in the windings when fed by frequency converters than with sinusoidal supply voltage. The effect of these voltages can be an increase of up to 2.5 times the nominal voltage of the motor. This stresses the motor winding insulation and can cause it to break down, resulting in possible sparking. ABB recommends the following:

- Between 500 V and 600 V, the motor needs to have reinforced winding insulation, or the drive must have a du/dt filter.
- Above 600 V, the motor needs to have reinforced winding insulation and the drive is required to have a du/dt filter.
- If the cable length between the drive and motor is greater than 150 meters and the voltage is 600–690 V, the motor must have reinforced winding insulation.

— Typical accumulated voltage.

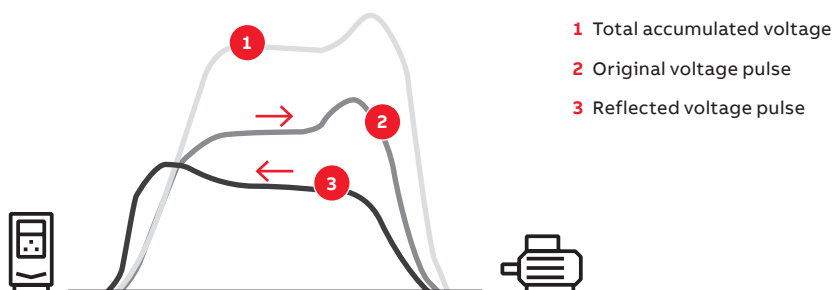

**Protecting against bearing currents**

AC drive can cause common mode voltages that induce voltages across motor bearings, leading to current flow through the motor bearings. To protect against bearing currents, ABB recommends the following:

- IEC 280 frame motors and above should have insulated non-drive end bearings in order to break circulating current paths.
- For IEC 355 frame motors and larger, in addition to the insulated non-drive end bearings, the drive should also have a common mode filter installed.

**Protecting against motor overheating**

To protect against the motor overheating, it is essential to understand and keep the motor temperature under control. The connection

between the motor’s running speed and load capacity must be known (load capacity curves). To ensure safe operation, the motor and drive combination needs to be sized correctly so it does not exceed the load capacity curve, and the rating plate information must be followed. To protect against motor heating, ABB recommends some possible solutions:

- A separate, constant-speed fan to increase cooling capacity and load capacity at low speeds.
- Directly measuring the motor’s surface temperature and using the data to control the shutdown of that motor.
- Monitoring and controlling the power fed to the motor.
- Limiting the load on the motor to prevent loads that cause higher motor heating.

Typical motor load capacity curves

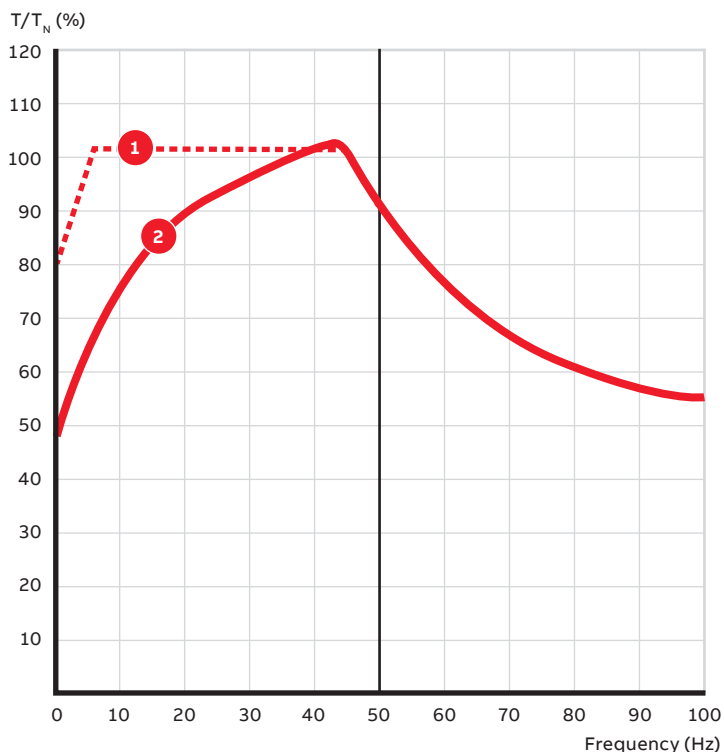
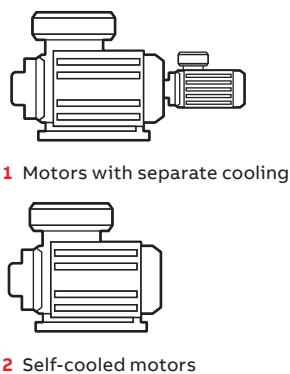

Selection table for ABB motor insulations and drive filters

Supply voltage	Motor frame size	Winding insulation	Motor bearings	Drive filters
≤500 V	≤IEC 250	ABB standard insulation	Standard bearing	No filter needed
	IEC 280–315	ABB standard insulation	Insulated non-drive end bearing	No filter needed
	IEC 355–450	ABB standard insulation	Insulated non-drive end bearing	Common mode filter
≤600 V	≤IEC 250	ABB standard insulation	Standard bearing	du/dt filter
		ABB special insulation (variant code 405)	Standard bearing	No filter needed
	IEC 280–315	ABB standard insulation	Insulated non-drive end bearing	du/dt filter
		ABB special insulation (variant code 405)	Insulated non-drive end bearing	No filter needed
	IEC 355–450	ABB standard insulation	Insulated non-drive end bearing	du/dt filter, common mode filter
		ABB special insulation (variant code 405)	Insulated non-drive end bearing	Common mode filter
≤690 V	≤IEC 250	ABB special insulation (variant code 405)	Standard bearing	du/dt filter
	IEC 280–315	ABB special insulation (variant code 405)	Insulated non-drive end bearing	du/dt filter
	IEC 355–450	ABB special insulation (variant code 405)	Insulated non-drive end bearing	du/dt filter, common mode filter
600–690 V with cable length over 150 m	≤IEC 250	ABB special insulation	Standard bearing	No filter needed
	IEC 280–315	ABB special insulation	Insulated bearing	No filter needed
	IEC 355–450	ABB special insulation	Insulated bearing	Common mode filter

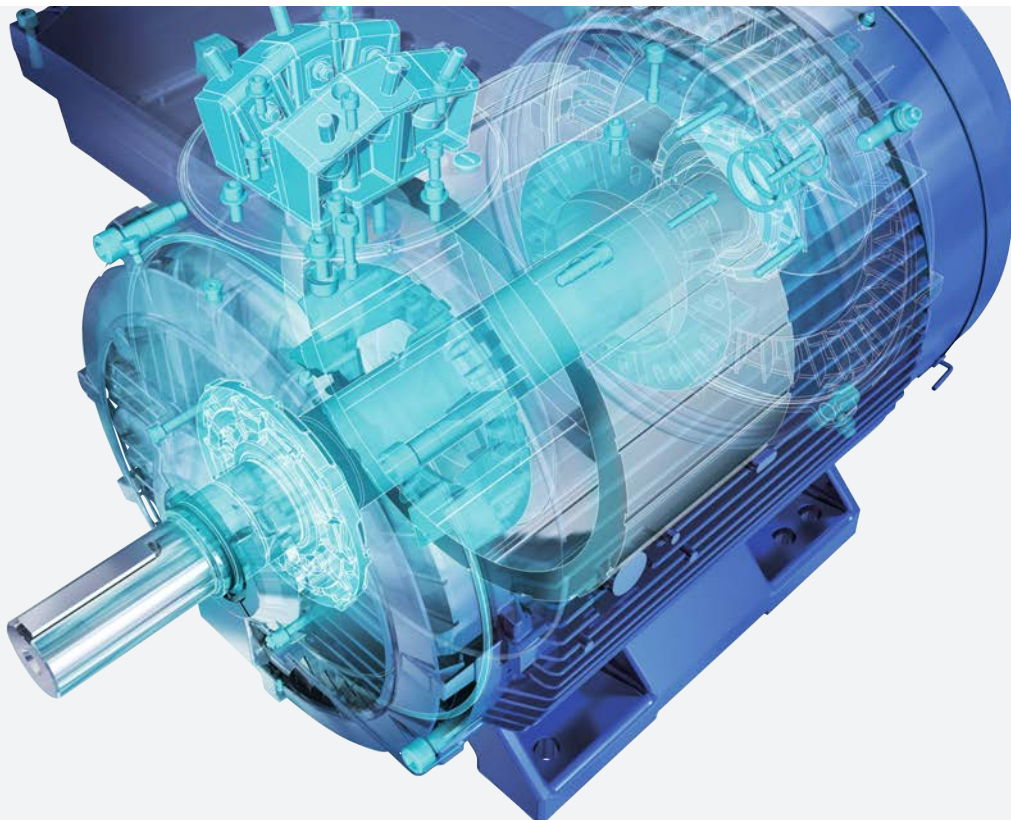

—  
01



# ATEX-certified safety functions

## Integrated into variable speed drives

The purpose of the safety functions is to disconnect the motor from the power supply.

—  
01 ACS880 industrial drives.

Many variable speed drives (VSDs) include built-in safety functions for explosive atmospheres (e.g. the Safe Motor Temperature (SMT) function, defined in EN/IEC 61800-5-2). Drives with integrated safety functions for use in protecting motors in explosive atmospheres are certified as protective devices under ATEX. The safety functions for explosive atmospheres include interfaces to PTC/Pt100 sensors for implementing overtemperature protection for a motor. In many cases, integrating protective devices inside a VSD is the easiest option, as installing external devices can be challenging. The protective devices can be integrated into the VSD with a thermistor protection module, which disconnects the motor from the power supply before the motor overheats and causes a risk of explosion in an potentially explosive atmosphere.

### Example of protective device marking

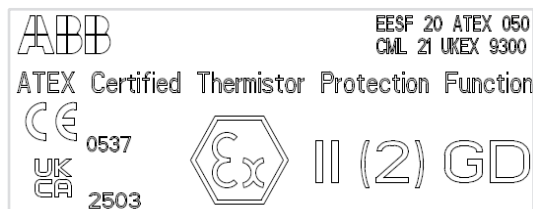

—  
Parentheses indicate that a safety device can be used to protect products with equipment categories 2 and 3, but the safety device itself and the drive where it is integrated must be installed in a safe area.

The thermistor circuit from the motor is directly connected to the module.

Under ATEX (and UKEX in United Kingdom), protective devices must be certified and marked similarly to the way motors are marked. The marking of a protective device can be found on the drive in which it is integrated. The ATEX and UKEX markings for the protective device relates only to the safety function integrated into that drive. The marking does not indicate that the drive has been tested and certified with a motor. The protective devices, as with variable speed drives in which protective devices are integrated, do not typically have an Ex protection enclosure. Therefore, they can only be located outside potentially explosive atmospheres. In the ATEX/UKEX conformity marking, this is indicated by parentheses around the equipment category number, e.g. (2).

### Example of integrated thermistor protection

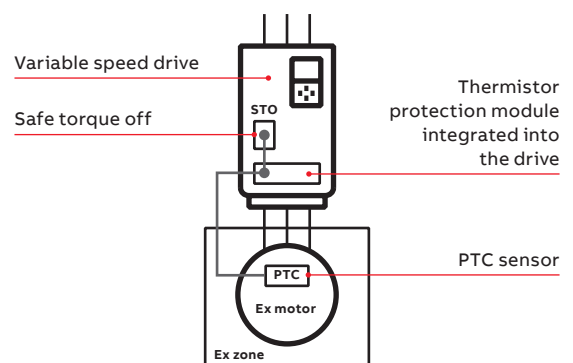

# Selecting motors and drives for explosive atmospheres

When selecting motors and drives for explosive atmospheres, the motor manufacturer’s instructions and recommendations must be followed.

—  
01 Low voltage  
flameproof motors  
Ex d.

Since only the motor can be installed in a potentially explosive atmosphere, with the drive always in a safe area, the instructions are intended to prevent the motor from overheating or creating any sparks. To ensure safe operation, certain issues need to be considered when selecting a motor together with a drive.

### Requirements

Choosing a motor and drive combination starts with collecting the customer requirements for ambient conditions, supply voltage and frequency, motor shaft speed area, motor output load, load type and overload requirement, efficiency requirements, as well as the zone, gas/dust group, temperature class and Ex protection type required. The first step is to choose the motor.

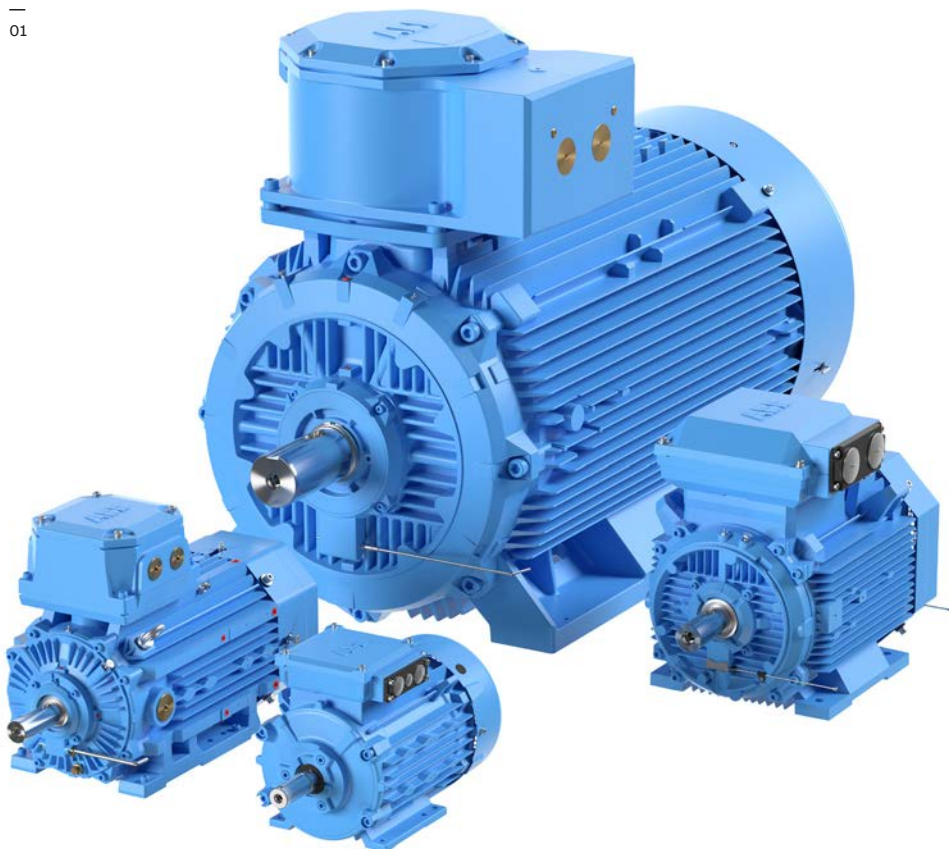

### **Selecting a motor and a drive based on requirements**

Check the availability of the motor and drive, the motor's certificate, and whether the certificate is valid for the frequency converter operation and under what conditions.

### **Dimensioning the motor and drive**

When dimensioning a motor for variable-speed applications, continuous thermal dimensioning and short-time overload capacity need to be considered. Also, limiting the switching frequency via Ex parameters will derate the amount of current and should be taken into account in the calculations.

The most convenient method to dimension the motor is to use ABB's DriveSize program. This tool can be downloaded from the ABB website ([new.abb.com/drives/software-tools/drivesize](http://new.abb.com/drives/software-tools/drivesize)).

Dimensioning can also be performed for ABB converters using motor load capacity curves. The load capacity curves show the maximum permitted continuous output torque of the motor as a function of supply frequency. The output torque is given as a percentage of the motor's nominal torque. The load capacity curves are based on nominal supply voltage.

**Note:** The maximum speed of the motor must not be exceeded!

Load capacity curves are calculated for a specific switching frequency depending on the ABB converter type. Since the switching frequency is different for different converters and load types, to ensure safe operation – especially with non-ABB drives – the combination of motor and drive must be tested for the specific type of protection needed. The alternative is to connect the internal temperature sensors in the motor to a certified

PTC/Pt100 relay that controls the main contactor of the drive and disconnects the motor from the power supply if the temperature limit is exceeded.

**Note:** Any filters that are fitted must be taken into account when dimensioning the motor!

Load capacity curves and more information can be found in the "Low voltage motors for explosive atmospheres" catalogue.

### **Other issues to consider**

Short-time overload capacity, filters and insulation, ambient conditions, voltage drops in long cables.

### **Selecting insulation and filters**

Choose the insulation and filters according to voltage and frame size. Different motor manufactures have different instructions.

### **Thermal protection**

Depending on the motor protection type, different manufacturers take a different approach to fulfilling the requirement of the standards. Check whether the combination has been type-tested and whether overtemperature protection is required in the certificate. Choose the ATEX-certified safety devices accordingly.

### **Installation**

Follow the installation instructions from the motor manufacturer – especially the cable and EMC recommendations in accordance with local regulations. Configure the drive according to the values on the motor rating plate and drive rating plate. Check that the drive's switching frequency can be limited to the value required by the motor manufacturer. Additional safety can be achieved by commissioning the load capacity curve, if available.

—  
For more information, please contact  
your local ABB representative or visit

[new.abb.com/drives](https://new.abb.com/drives)

[new.abb.com/motors-generators](https://new.abb.com/motors-generators)

[new.abb.com/drives/segments/motors-and-drives-in-potentially-explosive-atmospheres](https://new.abb.com/drives/segments/motors-and-drives-in-potentially-explosive-atmospheres)

